



BAADER Cool-Ceramic Safety HERSCHEL PRISM MARK II



Available in the following versions:

- **Visual** #2956510V with 7.5nm Solar Continuum Filter and ND 3.0 Neutral Density Filter
- **Photo** #2956510P with 7.5nm Solar Continuum Filter and ND 3.0/1.8/0.9/0.6 Filters

Instruction Manual and Application Examples

Congratulations on your purchase of the Cool Ceramic Safety (CCS) Herschel Prism Mark II. It can give you a lifetime of stunning images if you use it correctly.

For your own safety when observing the sun and for best results, we recommend that you spend a few minutes reading this instruction manual before using your Herschel prism.

The Herschel prism is available in a visual version (#2956510V) and a photographic version (#2956510P). They differ only in the scope of delivery and are described together.



- ver 10/23 -



BAADER PLANETARIUM

G
M
B
H

Zur Sternwarte 4 • D-82291 Mammendorf • Tel. +49 (0) 8145 / 8089-0 • Fax +49 (0) 8145 / 8089-105
www.baader-planetarium.com • kontakt@baader-planetarium.de • www.celestron.de

Safety Instructions	3
<i>For photography, please note:</i>	4
<i>Further important notes.</i>	4
THE SAFETY HERSCHEL PRISM	5
Scope of Delivery	5
Technical data and most important optional adapters	6
<i>Telescope side connection options (included as standard)</i>	6
<i>Additional filters (included as standard)</i>	6
<i>Connection options on the eyepiece side (included as standard)</i>	6
<i>Technical data</i>	6
Recommended accessories	6
The light path inside of the Herschel prism	7
Connecting to the telescope	7
The filters and the rotating filter holder	8
<i>The rotatable filter holder for brightness adjustment with a polarising filter</i>	9
<i>Baader 7.5 nm Solar Continuum Filter 2" (540 nm) #2961581</i>	10
<i>The ND-Filters</i>	11
<i>The Filter Crown Tool</i>	11
Accessories on the Herschel prism	12
<i>Eyepieces (2" and 1¼")</i>	12
<i>Bino-viewers on the Safety-Cool-Ceramic Herschel prism</i>	12
<i>Attaching a camera</i>	14
<i>The FFC Fluorite Projection Lens System on the CCS Herschel Prism Mark II</i>	15
<i>UFC filter drawers</i>	16
Shortening the overall length for connecting long accessories	16
The Herschel prism for Advanced Users	18
<i>Solar photography in calcium light</i>	18
<i>1¼" filters</i>	18
<i>Infrared pass filter</i>	19
<i>TriBand and other telescopes</i>	19
Observing Techniques	20
<i>Hints and tips</i>	20
Visual observation	20
Photography	22
<i>Focal photography (= direct connection of a camera body)</i>	22
<i>Afocal photography (using a digital camera with a fixed lens)</i>	22
<i>Projection photography and focal length extension</i>	23
<i>Tips for photographic observation</i>	24
The H-alpha-Sun	25

Safety Instructions



Observing the sun in white light (i.e. the photosphere in the continuum), including sunspots, granulation and solar flares, is exciting – but it is not without danger if the following safety instructions are not observed. If used improperly, eye damage - up to and including complete blindness – cannot be ruled out. We therefore ask you to study our safety instructions carefully.

The Herschel safety prism was specially designed for solar observation as an accessory for refractors. Even with an inexpensive refractor of about 80 mm aperture, you can observe all solar phenomena in white light that are accessible to the amateur.

The Safety Herschel Prism is an accessory for the serious amateur. Its use on a telescope requires responsible handling, so the following applies to visual observation:

- Never remove the 2" grey filter / ND filter 1:1000, density 3.0, which is already pre-mounted in the prism housing for visual observation, and use at least one other filter, either the Solar Continuum filter included in the scope of delivery, a neutral density filter or a single polarising filter.
- If you are using more than one telescope on your mount, make sure that the light inlets of all other instruments (including finder scopes) are securely closed before pointing the telescopes at the Sun.
- Always mount the Herschel prism on the focuser before pointing the telescope at the Sun.
- Never leave the telescope unattended, especially when observing the sun with children
- We have successfully used the Herschel prism on telescopes with apertures of 6 and 8 inch. However, because of the intense heat, we still recommend swinging the telescope out of the sun or covering it when not observing – take a break every hour or so to allow the equipment to cool down. The limit for the focal length is set by the 2" nose piece. For every metre of focal length, the solar image is about 1 cm, so the focal length should be no longer than 4.5 metres. If you can use your telescope with a 2" focuser for solar projection, you can also use the Herschel prism.
- Do not use the Herschel prism on telescopes with an additional corrector, reducer or flattener near the back of the OTA, as these components may otherwise heat up too much.
- To avoid overheating, we recommend using the Herschel prism only on telescopes with a focal ratio of f/6 or slower.

When using this BAADER safety Herschel prism with light trap ("heat cage") and ceramic end plate, no more dangerous light escapes from the housing. This makes the Herschel prism a safe instrument – also and especially for school astronomy. All necessary filters – including an optional polarising filter instead of the Solar Continuum Filter – can remain permanently in the Herschel prism, so there is no danger when changing eyepieces.

For photography, please note:

- Make sure that the filters are strong enough for focal solar photography – start with the pre-mounted filters for visual observation and gradually replace the 2" ND filter (1:1000, ND=3.0) which is pre-mounted in the prism housing with weaker filters, starting with the ND1.8 (see also page 9). Photographically, we recommend to always use the Solar Continuum filter to achieve a better contrast.
- Depending on the focal ratio of the telescope, the image may appear too bright in the viewfinder of a DSLR. In this case, hold a suitable filter (e.g. a neutral density filter # 2458245 / ND=1.8, 1:64) between the eye and the camera viewfinder, or use the LiveView of the camera if possible.

Further important notes

1. Never install any filter directly in front of the Herschel prism. When observing the sun with any Herschel prism, the unfiltered sunlight hits the prism with full energy. For this reason, additional filters or polarisers must never be mounted between the telescope objective and the Herschel prism – i.e. "in front of" the Herschel prism – as the heat load would be so high that any lens or filter installed in front of the Herschel prism would immediately shatter. In the exact unprotected focus of a 6" refractor, f/6 to f/15, temperatures of up to 600 degrees Celsius prevail.
2. If the photographic version of the Herschel prism is to be used for visual observation, make sure before each visual observation that the 1:1000 Neutral Density filter (ND = 3.0 / #2458332) has been reinserted on telescope-side in the rotatable filter mount and that the sunlight is sufficiently attenuated for visual observation by another filter (Solar Continuum, ND or polarising filter). Use the article number on the filter cell (ND 3.0 = #2458332) to check that the correct filter for visual observation is really in the beam of light.
3. Under no circumstances should welding glasses, black-exposed films or similar aids be used as additional filters for visual observation, since in almost all cases these allow the infrared radiation – which is harmful to the eye – to pass unnoticed.
4. Refractors with Petzval systems or other telescopes that have glass in the light path near the focal point are also not suitable for the use of a Herschel prism. In general, any Herschel prism may only be used on suitable refractors and only without further filters/optics between the objective and the Herschel prism. Multi-lens systems pose no problem as long as the optics are close to the front of the telescope. As long as the light has not been focused (i.e. the energy is not yet concentrated close to the focal point), the heat input is not higher than the solar energy on a white surface in summer. All refractor optics, whether oil-filled or with an air-gap, which are sold by Baader Planetarium, are suitable for a Herschel prism. The oils used are all UV-resistant. (However, we can only speak here for the products of the brands we know – if necessary, check the manual of your telescope to see if it is suitable for solar projection).
5. Reflecting telescopes without a special coating are not suitable for solar observation with a Herschel prism. With them, optical and mechanical components (secondary mirrors, mirror mounts, etc.) are used close to the focal point and can be destroyed by the high heat load. The only exception are the Baader Planetarium Triband telescopes, which were specially designed for this purpose (see p. 19).

If you have, for example, a Newtonian, Maksutov, Ritchey-Chretien or Schmidt-Cassegrain telescope, the light and heat filtering must take place in front of the telescope tube. In the past, plane-parallel glass solar filters were used for this purpose, but these have largely been replaced by the inexpensive BAADER AstroSolar film. You can find more information on this on our website at:

<https://www.baader-planetarium.com/en/solar-observation.html>
or visit [astrosolar.com](https://www.baader-planetarium.com/en/solar-observation.html)

THE SAFETY HERSCHEL PRISM

Scope of Delivery

The Herschel prism is supplied in the **visual version** (#2956510V) with the following accessories:

- 1 Cool Ceramic Safety Herschel prism MK II
– with 2" nose piece and 2" Baader ClickLock® eyepiece clamp
- 2 2" Baader Neutral Density Filter ND 3.0 (1:1000, transmission 0.1%) #2458332
- 3 Baader 7.5 nm Solar Continuum Filter 2" (540 nm) #2961581
- 4 1.3 mm and 1.5 mm Allen key
- 5 sturdy transport case made of ABS plastic with seal and air seal
- 6 Filter crown tool

Both filters (2 and 3) are already pre-mounted in the upper part of the prism housing.

The **photographic version** (#2956510P) has the same accessories as the visual version, and additionally contains

- 7 one 2" neutral density filter each of the densities ND0.6 (#2458321), ND0.9 (#2458322) and ND1.8 (#2458331).



Technical data and most important optional adapters

Telescope side connection options (included as standard)

- 2" (50.8 mm) nose piece with safety kerfs and M48 filter thread
- Ring dove tail S58 x 3.7 mm, for connection e.g. to Zeiss M68 and other Baader connection standards with optional adapters

Additional filters (included as standard)

- Neutral density filter (grey filter) 2", ND 3.0 (1:1000, transmission 0.1%) #2458332
- Baader 7.5 nm Solar Continuum Filter (540 nm), 2" #2961581

Both filters are pre-mounted in the rotatable filter mount of the Herschel prism.

The photographic version of the Herschel prism additionally contains the three filters

- Neutral density filter (grey filter) 2", ND 0.6 (T=25%) #2458321
- Neutral density filter (grey filter) 2", ND 0.9 (T=12,5%) #2458322
- Neutral density filter (grey filter) 2", ND 1.8 (T=1,5%) #2458331

These filters are also available separately.

Connection options on the eyepiece side (included as standard)

- 2" (50.8 mm) ClickLock® clamp with brass clamping ring, optical length 30 mm
- S58 ring dovetail, exactly the same as on the Diamond Steeltrack® focusers

Technical data

Optical length:	As supplied with ClickLock® eyepiece clamp: 117 mm without filter With two filters of 2 mm glass thickness (ND 3, SCT): 115 mm With optional SteelTrack M48/M68/T-2 adapter instead of ClickLock® eyepiece clamp: 85-86 mm without filter
Weight:	650g single unit, ~1,6 kg total weight incl. case
Housing:	cast metall, milled matt black anodised and pearl white textured finish Three-point adjustment system

Recommended accessories

- 2" polarising filter, single #2408342, for stepless brightness control
- Reducer to 1¼", e.g. Baader 2" to 1¼" ClickLock® reducer #2956214
- S58 Steeltrack adapters allow the 2" ClickLock® eyepiece clamp to be replaced with one of the following short length adapters:
 - Diamond Steeltrack® T-2 Adapter #2957202, optical length 2 mm.
 - Diamond Steeltrack® M48 adapter #2957204, optical length 1 mm
 - Diamond Steeltrack® M68i adapter #2957207, optical length 2 mm

The light path inside of the Herschel prism

The diagram on the right shows the path of light inside of the Herschel prism. The sunlight enters the prism from the left. Approximately 4.6% of the sunlight is directed upwards at a right angle into the eyepiece or camera for observation. Further grey filters dim the light even more to a harmless level.

The disproportionately larger, higher-energy portion of 95.4% of the radiation passes through the prism body and would form a focal point in the "air" far outside the prism housing.

A heat-absorbing special ceramic as a closure of the light trap ("heat cage") absorbs radiant heat – like the heat tiles on the space shuttle – without heating the surroundings too much. The housing, which is closed except for the ventilation slots, reliably prevents any risk of bright light reaching your eye. Since the "heat cage" is only connected to the prism housing via four screws, there is practically no heat transfer to the prism itself. The ceramic plate also acts as a viewing screen for the sunlight beam. Positioning the sun in the centre of the telescope's field of view is thus easy.

The 2" ClickLock® eyepiece clamp is used to hold eyepieces or other accessories. With a 15° turn you clamp any eyepiece bombproof – even in winter with thick gloves.



Never use Filters in front of the Herschel Prism:

For manufacturing reasons, the 2" nose piece of the Herschel prism also has a female M48 filter thread as it is common for 2" filters. In the case of the Herschel prism, however, no filters must be mounted here, as any filter inserted at this point will become very hot and thus be destroyed (see also the safety instructions on page 3). Any optical accessories must be mounted *after* the prism (i.e. on the eyepiece side).

Connecting to the telescope

The Herschel prism is attached to the telescope in exactly the same way as a 2" star diagonal. Make sure that it is securely held in the telescope's focuser.

Owners of Diamond SteelTrack® focusers can also attach the Herschel prism permanently to the focuser. This is particularly interesting for purely solar telescopes and in public use, so that no one can remove the Herschel prism. To do this, simply unscrew the 2" nose piece and attach the Herschel prism to your Diamond SteelTrack® focuser using the S58 ring dovetail instead of the eyepiece clamp.



The filters and the rotating filter holder

In both versions of the Herschel prism (visual and photographic), two Baader 2" filters are pre-installed directly above the prism when delivered. The first filter when looking from the telescope (i.e. directly above the prism) is a 2" 7.5 nm Solar Continuum filter – with the more reflective surface oriented towards the prism surface. Above this –

i.e. directly in front of the eyepiece – a ND3 (1:1000) neutral density filter is mounted for light attenuation. The orientation of the Solar Continuum Filter and the order in which both filters are installed ensure that the image of the sun is free of reflections.



Open the four screws ① in the prism body with the 1.5 mm allen wrench, to remove eyepiece clamp and filter holder. The Solar Continuum filter is mounted on the telescope side, to avoid reflections.

To change the pre-installed filters, the 2" ClickLock® eyepiece clamp with the rotating filter holder is removed from the prism housing by loosening the four screws ① .

Now you can unscrew the Solar Continuum filter, for example, and replace it with another filter, and/or replace the ND 3.0 with a weaker filter **for photography only**. If necessary, you can use the filter crown tool (page 11) for easier access. When assembling, make sure that the setting levers of the filter rotator ② and the ClickLock® are in a favourable position and that they still fit into the recesses of the storage case.

A maximum of two filters with Baader low-profile mount (LPFC – Low Profile Filter Cell, 6 mm height each) can be inserted into the filter holder on the telescope side. Further filters must be inserted in the eyepiece, the nose piece of the camera or a 1¼" reducer; a 2" filter can also be installed upside down in the eyepiece-side thread of the rotatable filter mount. **Take care of the maximum length for eyepieces.**



Caution when using eyepieces with dual 2"/1¼" nose piece:

The maximum insertion depth is 34.8 mm if a polarising filter is fitted, or 40 mm as supplied. Longer eyepieces may only be operated with an additional 2"/1¼" reducer or a 2" stop ring #2958027, i.e. using the eyepiece's 1¼" nose piece. Otherwise they would sit on the uppermost filter.



Use the stop ring #2958027 to avoid a long eyepiece touching a mirror or prism.

Particularly attractive for visual observations is the use of a single polarising filter #2408342 to adjust the brightness by simply rotating it. It is inserted into the filter holder on the eyepiece side. To do this, remove the eyepiece clamp by loosening the six screws ③ with the Allen key (you do not have to remove them completely). Then you can screw

in the filter. You can place the lever **2** on the rotator in such a way that the movement covers all brightness levels.

A polarising filter can also be used instead of the Solar Continuum filter, but only *behind* the ND3.0.

As already mentioned in the safety instructions, the ND 3 filter should only be removed during photographic observation in eyepiece projection or with Barlow lenses in order to achieve particularly short exposure times. To use another filter, proceed in reverse order.



Open the six screws **3** with the 1,3 mm allen wrench, to remove the eyepiece clamp and to install e. g. a polarising filter from the top in the rotatable filter holder.



Note the order of the filters!

To avoid reflections, use the following sequence

Herschel prism - Solar Continuum - ND3 - Filter holder

A polarising filter **must** always be installed behind the ND3, i.e. directly in the rotating filter holder, otherwise it can be damaged by the heat:

Herschel prism - Solar Continuum - ND3 - Filter Holder - Polarising Filter* or

Herschel prism - ND3 - Polarising Filter - Filter Holder

*in this configuration, the polarising filter is installed upside down, with the thread facing the telescope. This is only possible with linear polarising filters like #2408342; circular polarising filters only work in one direction. Do not use a polarising filter with a rotating filter cell (e.g. from a double polarising filter), as you would not be able to remove it.

The rotatable filter holder for brightness adjustment with a polarising filter

The biggest innovation of the Cool-Ceramic Safety Herschel prism Mark II compared to its predecessor is the revised filter holder, which can now be easily rotated from the outside via an easy-to-grip adjustment lever **2**. This allows a single 2" polarisation filter (#2408342) to be permanently placed in the beam of light. Since the Herschel prism already partially polarises the light, the image brightness can thus be conveniently adjusted to different magnifications by rotating the filter – without having to purchase several polarising filters for each eyepiece and/or the 1¼" reducer. This also means that this filter cannot be forgotten and safe observation of the sun is possible at all times. The lever **2** can be placed in several positions at the rotating filter holder, so that it covers the brightness levels from dim to bright.

For visual observation, you can simply use the position that provides a comfortable image brightness. Always place the filter on the eyepiece side, behind the ND3 – otherwise, it might get damaged.

When photographing the sun, please note that you should take new flats if you move the camera or the filter pack.

Baader 7.5 nm Solar Continuum Filter 2" (540 nm) #2961581 (included in delivery)

The Solar Continuum Filter (SC filter for short) is a very narrow-band filter (half-width 7.5 nm nanometres, see transmission curve on the right) at a central wavelength of 540 nm at maximum transmission. It brings the following advantages for solar observation:

Most two-lens achromatic telescopes are not equally well corrected across all colours of the spectrum.

With these lenses, the Solar Continuum Filter isolates the spectral range that is best corrected for these lenses. This brings out the best possible image from an inexpensive refractor (all other colour ranges are completely filtered out). This narrow band filtering (there is still enough image brightness) is noticeable in a clear increase in contrast of the solar image. This way you can use much higher magnifications.

In addition, the granulation of the sun can be observed with particularly high contrast in this spectral range.

Furthermore, the BAADER Solar Continuum Filter generally minimizes the effects of seeing (air turbulence), because the short-wave light below 535 nanometres is blocked (the longer the wavelength of the light, the less noticeable are thermally induced seeing effects).

With apochromatic refractors (very high-quality, without colour aberrations, e.g. Astro Physics, TEC), it may be possible to work without the Solar Continuum Filter visually and observe the sun in pure white light with the same contrast as is possible with simpler achromatic optics using only the Solar Continuum Filter. Especially when photographing with monochrome cameras, however, even high-quality apochromats benefit from the use of the Solar Continuum Filter.

The two images on the right show the sun once without and once with the Solar Continuum Filter through a 150/2250 Zeiss AS refractor. In the upper image, an additional ND 0.9 filter was used to achieve comparable exposure times and to compensate for the influence of air turbulence for this comparison.

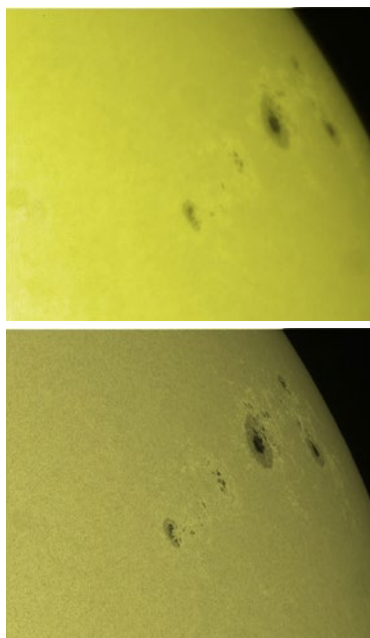
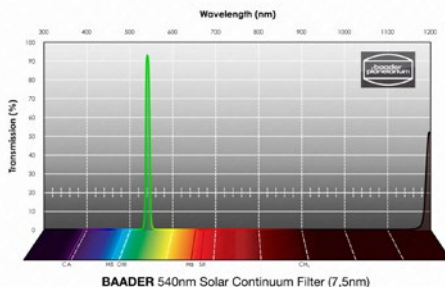

The sun in a Zeiss AS 150/2250 telescope, with similar exposure times. Above: Herschel prism, ND3 and ND0,9; below: Herschel prism, ND3 and Solar Continuum 7,5nm.

The ND-Filters

The plano-optically polished neutral density filter (grey filter) ND 3.0 (T=0.1%) #2458332 is pre-installed on delivery and must not be removed under any circumstances for visual observation, and it must be supplemented by another filter.

The photographic version of the Herschel prism comes with three additional neutral density filters. These filters are used to achieve a sufficiently bright image when photographing with extended focal lengths (or slow focal ratios).

If the camera image is too dark, first remove any built-in optional polarising filter before replacing the ND 3.0 with the ND 1.8 or even weaker filters. You can also combine two filters to achieve the desired brightness.



After each use, always rebuild the Herschel prism to the visual configuration (ND3+SC filters) – this will help you avoid using it for visual observation with the wrong filters, when you may not check beforehand that the correct filters are in place.

The visual version of the Herschel prism can be upgraded to the photographic version at any time. All you need are these three filters:

- Neutral Density Filter 2", ND 1,8 (T=1,5%) #2458331
- Neutral Density Filter 2", ND 0,9 (T=12,5%) #2458322
- Neutral Density Filter 2", ND 0,6 (T=25%) #2458321

The Filter Crown Tool

The filter crown tool is used to loosen filters that are difficult to access. The thin filter cells of modern filters can become slightly bent and thus get stuck in the thread if you can only barely grab them with two fingers.

If the filter in the Herschel prism cannot be moved with your fingers, place the filter crown tool on the top of the filter. This will allow you to unscrew it without applying uneven force to it. The tool connects to a large surface so that a filter can be easily removed. Please note that the filter crown tool is only compatible with the current Baader LPFC filter cells, the function with older mounts or filters from other manufacturers is not guaranteed.



The filter crown tool fits onto the modern 2" Baader filter cells.

Accessories on the Herschel prism

Eyepieces (2" and 1¼")

2" eyepieces are used as with any 2" star diagonal and are securely clamped by turning the ClickLock® a few degrees. The Baader ClickLock® is a precisely fitting, very solid eyepiece clamp without clamping screws. Any accessories that are inserted sit securely and are still not scratched! You'll never have to fiddle with small clamping screws again – instead, simply turn the upper part of the eyepiece clamp by a few degrees and the eyepiece is firmly fixed. This is no problem even when wearing gloves!

You do not have to tighten the ClickLock® clamps "until the blood runs out", because the mechanical principle comes from professional mechanical engineering. This is also how the tool holder on modern CNC machines works. By clever use of the lever forces, the tightening torque is increased many times over. The inserted object is held on three sides as with a quick-action chuck and can therefore no longer perform any tilting movements.

For 1.25" accessories you still need a reducer. We particularly recommend the 2" to 1¼" ClickLock® reducer #2956214 with 9.5 mm height, which also offers the ClickLock® convenience for 1¼" eyepieces, or the Pushfix 2" to 1¼" reducer #2408151 only 1 mm height, into which eyepieces can simply be inserted and which has.

Then you can use all 1¼" accessories for which the backfocus fits. If you have enough backfocus, you can even use the Q-Turret eyepiece holder, which needs about four centimetres extra backfocus.

Bino-viewers on the Safety-Cool-Ceramic Herschel prism

Due to their large optical length of about 11 cm, bino-viewers usually can't be used with the 2" eyepiece clamp of the Herschel prism (or with a 2" star diagonal). In combination with one of our bino viewers (MaxBright, MaxBright II, Mark V), the Herschel prism requires a very large backfocus of about 225 mm (about 110 mm for the bino viewer and 115 mm for the Herschel prism, plus some focusing reserve depending on the focus position of the eyepieces and dioptric compensation). In most cases, modern telescopes have a backfocus of about 150 to 180 mm. The combination therefore does not come into focus in most cases. You therefore need a glass path corrector that extends the focal length of your telescope and at the same time compensates for the colour error of the bino-viewer on fast optics. The overall length of the Herschel prism can also be reduced by 30 mm by replacing the eyepiece clamp.

The following values can be used as a basis for the necessary backfocus with a bino-viewer, either with ClickLock® or the T-2-adapter #2957202 instead:

	Herschel prism plus bino-viewer	+ 1.25x GPC	+ 1.7x GPC	+ 2,6x GPC
With 2" Clicklock® and 2" nosepiece	225 mm	190 mm	175 mm	105 mm
With T-2-Adapter + 7.5 mm extension	195 mm	165 mm	130 mm	75 mm

A 7.5 mm T-2 extension #1508155 is required to hold the glass path corrector (GPC) in place. When using the TQC quick changer, this can be omitted for the GPCs 1.25x and 1.7x; but the required back focus is only minimally shorter then.

Please note that these are approximate values that also depend on the dioptic correction setting.

You can easily determine the available backfocus of your refractor as follows.

Point your refractor without eyepiece at the moon and hold a blank sheet of paper behind it. The focuser must be fully retracted. Move the sheet in the air until the moon is in focus. Then measure the distance between the 2" eyepiece clamp on the refractor and the sheet of paper.

The measured value is the real backfocus of your telescope

Bino viewer with glasspath corrector and 2"/1,25" nose piece

Especially with the 2.6x glass path corrector #2456317 you will come into focus in most cases, even with the Clicklock® clamp. It is simply placed in the 1¼" or 2" nose-piece as described in the instructions for your bino viewer. At the same time, it extends the focal length by a factor of 2.6x, which is no disadvantage on the Sun: in the sky, the Sun appears about 0.5° large and thus still fits completely into the image even at a higher initial magnification. A telescope with 1000 mm focal length and 2.6x glass path corrector has an effective focal length of 2600 mm. A 32 mm Plössl with 50° field of view still provides a 0.6 degree field of view at 81x magnification on such a telescope.

Direct adaptation of a bino viewer with a glasspath corrector

For longer focal length telescopes or to use existing glass path correctors, you can also attach the bino viewer directly to your Herschel prism. For this you need the Diamond Steeltrack® T-2 adapter #2957202, which replaces the 2" ClickLock® clamp. To do this, proceed as described on page 16 in the chapter "Shortening the overall length".

Our bino viewers are equipped with either Zeiss ring dovetail (Mark V) or T-2 coupling nut (MaxBright I). The MaxBright II can be used with either ring dovetail or T-2 coupling nut. We recommend using the ring dovetail, as this allows the glass path correctors 1.25x and 1.7x to be mounted directly in the bino and makes handling much more convenient. For the glasspath corrector 2.6x or for using the T-2 coupling nut, you will need the 7.5 mm T-2 extension #1508155 which will securely hold the glasspath corrector in the T-2-adapter of the Herschel prism.

For bino-viewers with T-2 thread, proceed as follows:

Remove the ClickLock® eyepiece clamp as described on page 8 and replace it with the Diamond Steeltrack® S58/T-2 adapter #2957202.



The ClickLock® can be replaced with the S58/T-2-adapter #2957202. The filterholder remains at the Herschel prism



The glasspath correctors for bino-viewers with T-2-connection and the 2,6x glasspath corrector are placed into the 7,5mm T-2 extension #1508155.

Screw a 7.5 mm T-2 extension #1508155 onto the S58/T-2 adapter. Insert the glass-path corrector (1.25x: #2456314, 1.7x: #2456316, 2.6x: #2456317) into the 7.5 mm extension and fix it with the plastic centering ring which comes with the glasspath corrector. Now screw the binocular onto the Herschel wedge with the T-2 coupling nut. Rotate the binocular into a comfortable position and tighten the coupling nut.

For bino viewers with Zeiss ring dovetail, proceed as follows:

The **glass path corrector 2.6x** is inserted into the 7.5 mm extension #1508155 with the black centering ring as described above for bino-viewers with T-2 coupling nut. Then screw the T-2 quick changer (TQC heavy duty T-2 quick changer #2456313A or T-2 standard quick changer #2456313) onto the extension ring and insert the binocular with the ring dovetail. The glasspath corrector is held in place by the ring dovetail of the binocular.

The **glasspath correctors 1.25x and 1.7x** are screwed into the ring dovetail located on the bino viewer as usual without the black centering ring.

Remove the ClickLock® eyepiece clamp as described above and replace it with the Diamond Steeltrack® T-2 adapter #2957202. Screw the T-2 quick changer (TQC heavy duty T-2 quick changer #2456313A or T-2 standard quick changer #2456313) onto the T-2 thread of #2957202. Now you can attach the binocular to the T-2 quick coupler.



The 1.25x and 1.7x glasspath correctors can be mounted in the bino-viewer's dovetail. On the right is the Herschel prism with T-2 quick-changer.

Attaching a camera

Cameras with a long flange focal length, such as digital SLR cameras with a flange focal length of 55 mm, do not usually come into focus, as most refractors are designed to use these cameras without an additional star diagonal. In this case, you have to remove the 2" ClickLock® and replace it with the Diamond Steeltrack® T-2 adapter #2957202 with an optical length of 2 mm. To do this, proceed as described in the chapter "Shortening the overall length".

Astronomical cameras with a 1¼" or 2" nose piece can usually be used behind the Herschel prism without any problems.

Astronomical cameras with a T-2 thread can be used directly on the Herschel prism with the Baader 2" / T-2 (M48) nosepiece #2458130. Alternatively, as when using a DSLR, you can remove the 2" ClickLock® and screw the camera directly to the Herschel prism via the Diamond Steeltrack® T-2 adapter #2957202, optical length 2 mm, or via an additional, optional T-2 quick release.



The FFC Fluorite Projection Lens System on the CCS Herschel Prism Mark II.

Attention: Use FFC only with great care!

There is a risk of damage to the FFC and loss of warranty.

Probably the world's best projection lens for planetary projection photography is our Fluorite Flatfield Corrector (FFC), which allows a focal length extension of 3x to 8x.

Together with the Cool-Ceramic Herschel prism, this enables amazingly high-resolution images of the solar surface.

However, utmost care is required to avoid overheating the sensitive FFC lenses made of real fluorite crystal (no ED glass!). A crack in a fluorite lens due to excessive heat exposure can be detected by expert examination and a warranty claim is excluded. Repair or replacement of fluorite lenses is very expensive.

Firstly, in order to reliably prevent overheating, at least an ND 3.0 filter or (with a greatly reduced exposure time) an attenuating glass 1.8 or 0.9 must always be mounted in the housing of the Herschel prism (in front of the FFC).

For all types of solar projection photography, it is tempting to simply remove all the ND filters from the Herschel prism in order to literally "freeze" the turbulence in the Earth's atmosphere with the help of the resulting extremely short exposure times around 3 ms.

However, this means an extraordinarily rapid, shock-like heat increase for the sensitive fluorite crystal and an enormous heat load on all optical components above the Herschel prism (including the image sensor!). Nevertheless, this type of projection photography is becoming increasingly popular and, thanks to state-of-the-art mounts with extreme positioning accuracy and slew speeds of up to 20°/s, it is also possible.

For this type of photography, the telescope must practically only be pointed directly at the sun for the length of the exposure time (a maximum of 5 seconds in total), and we cannot accept any liability for the equipment connected to the focuser.

However, we expressly recommend that observers who do not specialise in solar photography always leave the visually mounted 2" filters in the CCS Herschel prism for safety's sake!



Possible configuration for the FFC

te

UFC filter drawers

You can insert a UFC filter drawer between the eyepiece clamp and the rotating filter holder, for example to quickly switch between a solar continuum filter for white light and the calcium filter during photography.

For this you need either

- Diamond Steeltrack® M48 adapter #2957204,
optical length 1 mm **plus**
Baader UFC S70 / M48 (w) telescope adapter (height: 1 mm) #2459129 **or**
- Diamond Steeltrack® T-2 adapter #2957202,
optical length 2 mm **plus**
Baader UFC S70 / T-2 (w) telescope adapter
(height: 1 mm) #2459130
as well as
- Baader UFC base, telescopic S70 dovetail
(height: 13 mm) #2459110 **and**
- a matching UFC camera adapter for your camera,
like
 - Baader S52 dovetail Camera-Adapter
for Wide-T-rings
optical height: 2 mm #2459119
 - Baader UFC T-2 (m) Camera-Adapter
optical height: 2 mm #2459115 or
 - Baader UFC M48 (m) Camera-Adapter
optical height: 2 mm #2459116



Herschel prism with UFC filter drawer
T-2-thread and an additional T-2 quick
changer

and of course the matching filter drawers. For T-2 and M48, there are also quick-changers available, to easily rotate or remove the camera.

Shortening the overall length for connecting long accessories

The overall length of the Herschel prism can be shortened by replacing the 30 mm long 2" eyepiece clamp with one of the Diamond Steeltrack® S58 adapters. A connection thread is then available directly on the prism housing.

Many manufacturers of refractors do not design the focal point position behind the end of the focuser with a large enough allowance to connect alternative accessories from other suppliers. In particular, SLR cameras with 55 mm flange focal length usually do not come into focus behind a 2" star diagonal or the Herschel prism: To avoid vignetting caused by the retracted focuser, the telescopes are designed so that a DSLR can only come into focus without additional accessories.

In this case, the S58 adapters to T-2, M48 or M68 described on page 6 are the solution to shorten the mechanical length of the Herschel prism by removing the 2" ClickLock® clamp and still keeping the absolutely necessary 2" ND 3.0 filter and the 2" solar continuum filter at the same place directly above the Herschel prism in the path of light.

To connect, proceed as follows, using the T-2 adapter #2957202 as an example:



1. Remove the 2" ClickLock® eyepiece clamp by unscrewing the six hexagon socket screws with the 1.3 mm hex key as described on page 9. It is not necessary to remove them completely. The filter holder with the filters remains at the Herschel prism.



2. Place the S58 adapter on the rotating filter holder, and hand-tighten the six hexagon socket screws. The T-2 thread now sits flush with the housing and can be used.



3. **Example:** Connecting a camera with a T-2 thread.



4. **Example:** A DSLR with an interchangeable lens can be connected directly to the T-2 thread via a T-2 ring. Under certain circumstances, the camera's flash shoe may bump against the Herschel prism. In rare cases, another short T-2 extension (or a quick release) is necessary.



5. With a T-2 quick-change system (#2456322 or #2456321, overall length 15 mm), a bino viewer can be connected directly, or other accessories such as cameras and eyepiece clamps can be quickly exchanged or aligned.

The Herschel prism for Advanced Users

Solar photography in calcium light

In the dark blue spectral range, around 400 nanometres, photospheric flares in the vicinity of sunspots, which can only be observed visually in white light near the edge of the sun, can also be made visible further towards the centre of the sun. To do this, the contrast of flare areas near the edge is dramatically increased with the Baader calcium filter Gen II #2961590. This filter, with a half-width of about five nanometres, only lets through the emission lines of calcium.

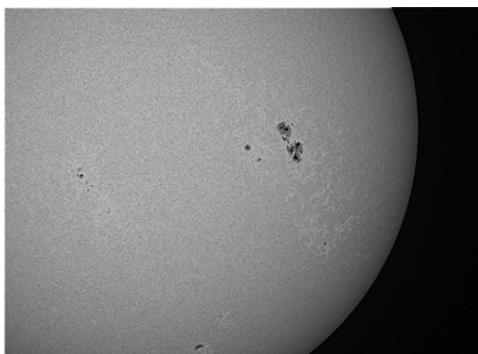

Calcium-line-image of the sun. Monochrome camera at Celestron ED80/600 with Herschel prism, ND1,8-filter und Baader Calcium-filter Gen II #2961590

To use this very narrow band filter, you should replace the ND3 filter with a weaker filter to achieve a sufficiently bright image. Try the ND1.8 first before trying even weaker filters if necessary. The Solar Continuum filter and any polarising filters must also be removed.

Please note: Since the human eye is virtually blind in the spectral range below 420 nm, visual observation is not possible. Only cameras can be used as sensors – preferably astronomical cameras or video modules.

It is a mystery to us why competitors offer "CaK" telescopes for visual use, while every tanning salon is legally obliged to warn against looking directly into UV-A radiation – and that is exactly what happens when you visually observe the calcium line below 400 nm.

To take advantage of the high quality of the Baader calcium filter in combination with a Herschel prism, the refractor objective should also be of high quality (apochromatic). Simple double-lens achromatic objectives are usually very poorly colour-corrected in the blue spectral range, so that no sharp images can be obtained in this spectral range with them.

1¼" filters

1¼" filters can be screwed directly into 1¼" eyepieces or cameras and used e.g. with the Baader 2" to 1¼" ClickLock® reducer #2956214 on the Herschel wedge. However, they cannot be inserted directly into the 2" filter holder of the Herschel wedge.

Alternatively, you can screw 1¼" filters directly into a 2" filter thread using the 1¼" filter holder for T-2 and 2" filter thread #1508031.

For cameras with 2" nose piece and T-2 adapter thread, you can replace the nose piece with Baader 1¼" T-2 nosepiece #2458106.



Infrared pass filter

While focal photography of the whole sun has few problems with air turbulence (seeing) due to short exposure times and low magnification, things change when you use projection photography. The larger the equivalent focal length, the longer the exposure time. This greatly increases the susceptibility to seeing effects.

Seeing effects are wavelength-dependent – stronger in the short-wave spectral range (blue), less in the long-wave spectral range (red). Therefore, it can be worthwhile – especially when shooting with video modules and long focal lengths – to use a very dark red filter to completely block the short-wave part of the spectrum. Ideally suited is the Baader IR pass filter (1¼": #2458386; 2": #2458386), which is also popular in planetary photography and significantly reduces seeing effects there as well. To use an IR pass filter, the Solar Continuum Filter must be removed. This filter can only be used photographically.

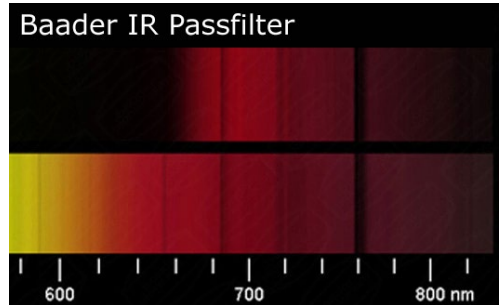

TriBand and other telescopes

Even though we wrote in this manual that the Herschel prism is only meant for refractors, there are two exceptions: The Baader TriBand Schmidt-Cassegrain telescopes and Schiefspiegler telescopes.

The Baader TriBand SCT are modified Schmidt-Cassegrain telescopes with 8", 9¼" and 11" apertures that have an energy protection filter integrated into the Schmidt corrector plate. Originally designed for high-resolution H-alpha observation with SolarSpectrum or Baader SunDancer filters, the special coating also allows both deep-sky narrowband photography and solar observation with a Herschel prism. Since the TriBand coating is not transparent at 540 nm, the SolarContinuum must be removed and replaced with an ND or polarising filter.



Schiefspiegler telescopes are somewhat out of fashion and are not currently in series production. However, they are the only reflecting telescopes that are obstruction-free and can provide sufficient backfocus for a Herschel prism. Please refer to the operating instructions of your telescope to find out whether your model is suitable for solar projection or a Herschel prism, or whether, for example, correction lenses close to the focus prevent this use.

Observing Techniques

It is particularly appealing to observe a complete solar cycle over its course of about 11 years. The last minimum with a virtually spotless sun was in 2019/2020. Since then the number of spots has been increasing again, probably ending at a spotless Sun again in 2031.

Hints and tips

Especially for solar observations, seeing (air flicker/air turbulence) plays a major role because the atmosphere heats up strongly during the day, especially in summer.

Depending on the observation site, there is a specific daily curve of seeing conditions (good and bad). Experience shows that there are two times of day when the seeing conditions are mostly passable; namely in the morning (before the atmosphere has heated up) and late in the afternoon (before sunset) when the atmosphere cools down slowly and continuously.

Furthermore, the line of sight towards the sun is important. If you look at the sun over an evenly vegetated area (park, meadow, water surface), the seeing conditions will be better than if you observe over "chaotically" built-up areas (houses, etc.).

As mentioned above, for regular solar observations it is important to determine the best seeing conditions for your own observing site.

Two further points to improve the seeing conditions – and thus the image quality:

- Use the Solar Continuum Filter as described above.
- During observation breaks, the telescope should not be pointed directly at the sun, so that the objective, the air column in the tube and also the Herschel prism can cool down.

Visual observation

Rim darkening

Rim darkening of the sun is a constant solar phenomenon and is immediately noticeable when the entire disk of the sun is observed in the telescope in an overview. Rim darkening occurs because the sun consists of hot gas whose temperature decreases towards the surface. In the centre of the observed solar disk, deeper, hotter regions can be seen, which radiate more strongly. Towards the edge, on the other hand, we are looking at less hot and therefore also less bright layers. If the sun were a solid body, no darkening of the edges would be observed.

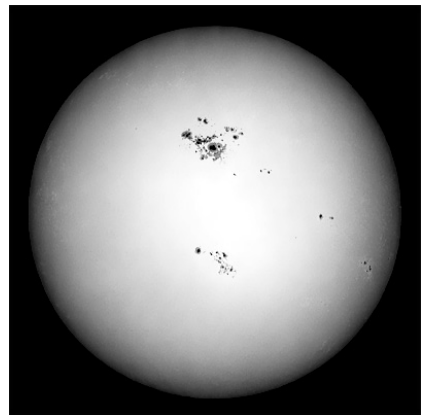

Sunspots

Sunspots consist of a core area (umbra) and a brighter "halo" (penumbra). Sunspots are cooler (about 4000 °C) than the undisturbed solar surface (about 5500 °C). At these points, magnetic fields "break through" the photosphere and interfere with the normal release of energy via the granules.

All sunspots go through an evolutionary cycle – usually from a small single spot to a complex group of spots with magnetic north and south poles. Changes in these complex groups are the fastest changes observable in the solar system – they can occur in a matter of minutes, making solar observation in white light particularly interesting.

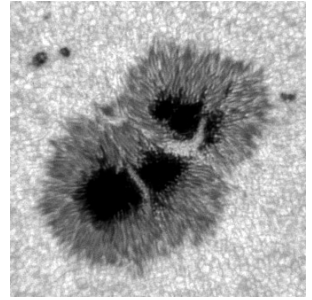

Other phenomena to observe

- Light bridges
- Umbral Dots
- Penumbra Filaments
- Schülen-Wilson phenomenon
- Photospheric flares

Flare regions are perceived as brightening of the solar surface and are usually located around sunspot groups. These flare regions are hotter than the normal photosphere. In white light observations with the Safety Herschel prism, flare regions are mainly observable at the edge of the Sun (see Fig. right).

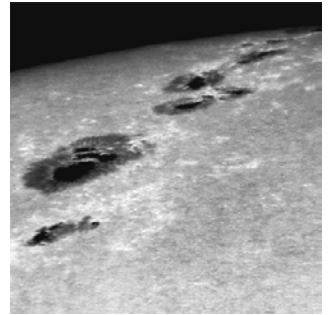

Tips for visual observation

If the solar image appears too bright, e.g. when using a very fast refractor or if the Solar Continuum Filter has been removed (leaving only the ND3 neutral density filter in the prism housing), either a single polarising filter or an additional neutral density filter of suitable density *must* be combined with the ND 3.0 filter. We offer three additional neutral density filters in densities 0.6, 0.9 and 1.8 – in both 2" and 1¼" filter diameters – which are also included with the photographic version of the Herschel prism.

All information in this manual refers to the use of the Safety Herschel prism with refractors with focal ratios between f/6 to f/15.

Photography

In solar photography, a general distinction is made between focal photography and photography with Barlow lenses or using eyepiece projection for focal length extension. The recording medium is a camera sensor. The phenomena that are documented are the same as described for visual observation.

Focal photography (= direct connection of a camera body)

Focal photography is always used when the complete solar disk is to be imaged. For this purpose, the camera (without lens) is connected directly to the Safety Herschel prism via a T-2 adapter, as shown in the picture on the right using a DSLR as an example. For best results, use a monochrome camera with the Solar Continuum filter.

As a rule of thumb for the size of the solar image, the following applies:

1 m telescopic focal length results in an approx. 1 cm large solar disc on the image plane

At a telescope focal length of two metres, the sun would be about two centimetres in size and would not fit completely onto an APS-C sensor with a sensor size of 22.5 mm × 15.0 mm. This rule of thumb is only a guideline, also the size of the sun's image changes in the course of the year due to the elliptical orbit of the earth.

First, leave the ND 3.0 and the Solar Continuum Filter installed and switch your camera to RAW mode. Exposure times should be around 1/1000 of a second (at low ISO values of around 125). This ensures that the seeing (air turbulence) is really "frozen". If 1/1000 sec. is not feasible (depending on the focal ratio of the lens), replace the ND 3.0 with the ND 1.8 filter to shorten the exposure time.

If you cannot get into focus, you can replace the eyepiece clamp with one of the S58 adapters with a ring dovetail and thus save about 30 mm of construction length.



Afocal photography (using a digital camera with a fixed lens)

Afocal photography is mostly used when there is no camera body without lens available, but the camera is equipped with a fixed lens (point-and-shoot camera). Afocal photography is a special version of projection photography. It is suitable both for overview photography (whole solar image) and for detailed photography. The change in the so-called equivalent focal length required for this is made by changing the focal length of the zoom lens of the recording camera or the eyepiece.

This shooting technique with selected digital viewfinder cameras can also be realised with BAADER accessories. You have three options for this:

- You can position lightweight compact cameras behind the eyepiece with the Microstage II Digiscoping Adapter #2450330.
- Camera lenses with a filter thread can be screwed to the eyepiece with the Hyperion DT rings. Our Hyperion and Morpheus eyepieces offer corresponding connection threads; slim eyepieces such as the Classic Ortho/Plössl with up to 38 mm diameter can be used with the Afocal Digital Projection System ADPS II with 2" nose piece #2458072.



Left: A compact camera with a MicroStage II; Center: Compact camera, attached to a Morpheus eyepiece using the filter thread of the camera lens; Right: Smartphone with Celestron NeXYZ Adapter.

- Modern smartphone cameras are amazingly powerful and can already deliver impressive images when you place them on the eyecup of the eyepiece. For best results, use a smartphone adapter such as the Celestron NeXYZ Universal 3-Axis Smartphone Adapter # 825821.

You can find more about this technique in our info brochure "Digiscopy – Camera Adaptations for Afocal Photography and Eyepiece Projection" (available as PDF download on www.baader-planetarium.com).



Projection photography and focal length extension

This technique is used whenever granulation or sunspots shall be photographed in high resolution and detail. For this, a focal length-extending system must be used. And here – despite the Herschel prism and 4.6% light transmission – the exposure times increase rapidly.

The camera is used without its own lens in order to keep the number of lenses low. Instead of individual images, short films of a maximum of 15-30 seconds are recorded – since the sun is very dynamic despite its size, details would already be washed out in longer sequences. These films are then further processed with software such as Autostacker! or Registax.

The necessary extension of the focal length is achieved either by

- eyepiece projection (with OPFA System # 2458142) or
- preferably by Barlow lenses, telecentric systems or even the FFC, see page 14.

Today's cameras with their small pixels do not need the very high magnifications achieved with eyepiece projection. A Barlow lens and even more a telecentric system is therefore to be preferred; for extension factors above 3x, the FFC is the first choice and achieves – compared to normal eyepiece projection – an unrivalled high quality of imaging.

For first test shots with a DSLR camera, a simple Barlow lens can be used, which approximately doubles the telescope focal length. For best results, use an astronomical camera, preferably in a monochrome version. The magnification factor depends on the distance of the Barlow lens to the camera sensor.

Please note:

Any focal length extension – whether by Barlow lens, eyepiece projection, teleconverter or FFC – must be introduced into the optical path *behind* the Herschel prism (i.e. on the camera side, between the camera and the Herschel prism).

Tips for photographic observation

Although the sun is bright enough, you cannot zoom in as high as you like. The achievable resolution is limited by three factors:

Air turbulence: It often limits the resolution to about one second of arc. Higher resolutions can only be achieved by "lucky imaging", i.e. by stacking numerous short-exposure images that practically freeze the air turbulence. For long-exposure deep-sky images, aim for an image scale of about one arcsecond per pixel; for the sun and planets, you can try up to 0.1-0.3" per pixel.

The resolving power of your telescope: Already with telescopes around 125 to 150 mm aperture you will reach the resolution of about one arc second which can be used for longer exposure times with good seeing. Larger telescopes offer the necessary reserves for moments with excellent seeing, or for use at very good locations, or especially for lucky imaging – that is, filming the sun and then stacking the best shots.

The pixel size of the camera, which must match the resolution of the telescope and the image scale. For this purpose, the focal length is adapted to the pixel size of the camera by means of a high-quality Barlow lens. As a rule of thumb, an image scale of about half the resolution of the telescope should be aimed for. For a 20-cm telescope with a resolution of 0.6", this means a scale of about 0.3"/pixel; for a 10-cm telescope with 1.3" resolution, this results in about 0.6"/pixel.

The resolution in arc seconds per pixel is calculated from

$$\text{resolution [arcsec]} = (\text{pixel size} / \text{focal length}) \times 206,265$$

The resolution of a telescope in seconds of arc at a wavelength of 540 nm is obtained as follows

$$\text{resolution [arcsec]} = 1,22 \times \frac{0,000\,000\,540\text{ mm}}{\text{telescope aperture [mm]}} \times \frac{360 \times 3600}{2\pi}$$

For best results, we also recommend using the Solar Continuum with a monochrome camera on apochromatic telescopes.

It is also advisable to take flats when taking photos of the sun to compensate for dust in the system/on the sensor. This can be done, for example, with a semi-transparent film in front of the lens.

The H-alpha-Sun

Finally, a note: Observing the prominences at the solar limb is not possible with a Herschel prism – not even in combination with an H-alpha filter for deep-sky observation. On the one hand, the Herschel prism also attenuates the H-alpha line, on the other hand, even very narrow-band deep-sky H-alpha filters with 3.5 nm are much wider-band than the special H-alpha filters with around 0.06 nm passband.

At www.baader-planetarium.com/en/solar-observation/solar-spectrum-h-alpha-filters.html you will find a selection of H-alpha filters for safe solar observation.

And now we wish you a lot of fun observing the sun in white light with the Safety Herschel prism.

Your BAADER Team

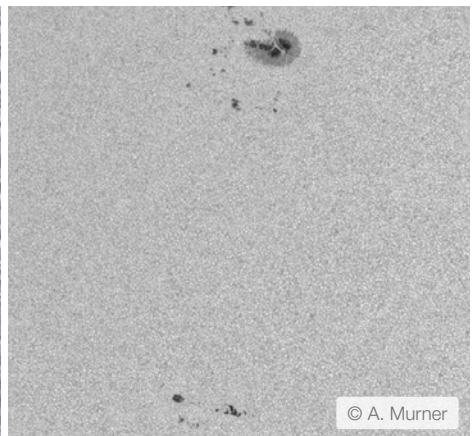
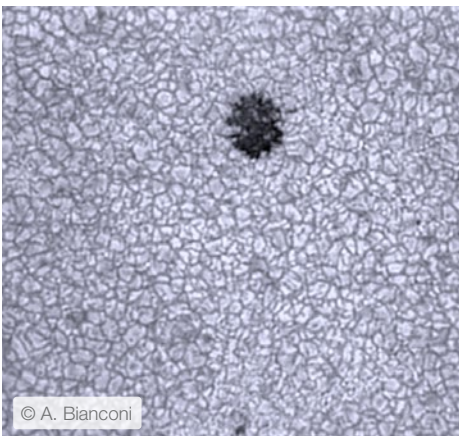
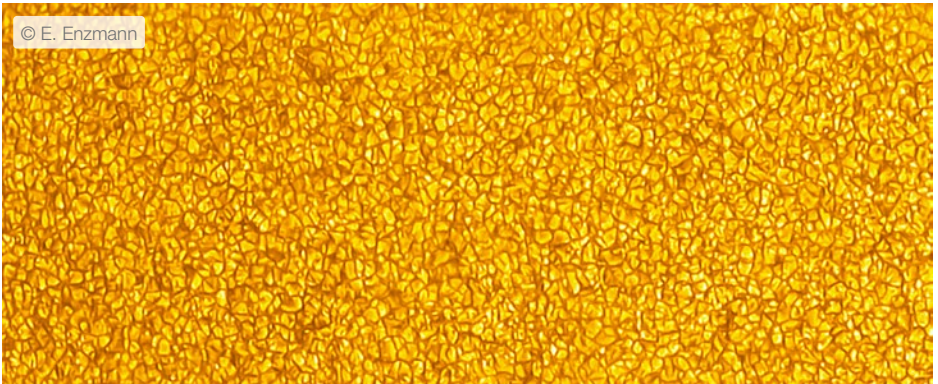

BAADER Cool-Ceramic Safety
HERSCHEL PRISM
MARK II

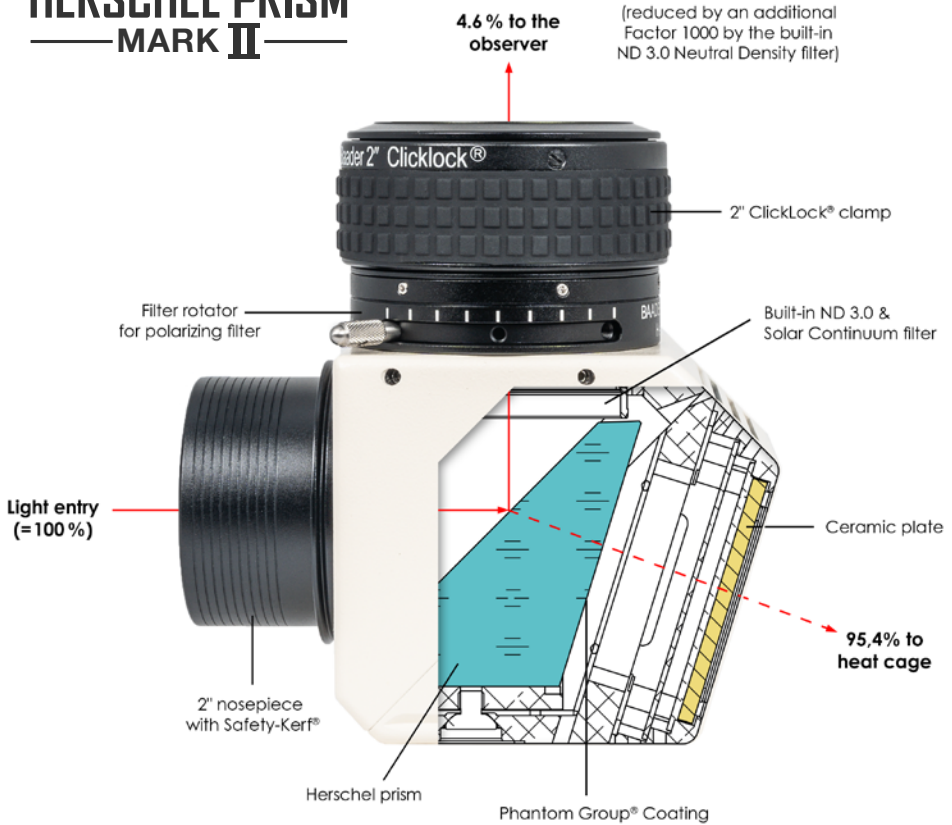

www.baader-planetarium.com

© Baader Planetarium GmbH. All Rights reserved. Products or instructions may change without notice or obligation. Images and illustrations may differ from the original products. We reserve the right of errors. Reproduction of this instruction manual, complete or in parts, only with written permission by



BAADER PLANETARIUM G M B H

Zur Sternwarte 4 • D-82291 Mammendorf • Tel. +49 (0) 8145 / 8089-0 • Fax +49 (0) 8145 / 8089-105
www.baader-planetarium.com • kontakt@baader-planetarium.de • www.celestron.de

